



NEW

Power Cube® SA/400 series

Wideband Medium-High Frequency 25 kW / 12.5 kW Green Generators



FEATURES / BENEFITS

- **HIGH POWER OUTPUT**
- **HIGH LEVEL OF PERFORMANCE** with minimal operating costs
- **AUTOMATIC TRACKING** and **BEST OPTIMIZATION TO LOAD**
- **CONSTANT, REPEATABLE POWER GENERATION** via microprocessor control
- **MINIMUM COOLING WATER FLOW** required
- **HIGH SAFETY:** output insulation from the mains
- **HIGHLY INTEGRATED** with a small footprint
- **USER FRIENDLY OPERATIONS** through graphical touch-screen interface
- **STAINLESS STEEL CASING**
- **COMPLIANT WITH** Electrical Safety and Electromagnetic Compatibility Regulations

MODELS

- ▶ **PW3-12.5-SA/400** 12.5 kW
- ▶ **PW3-2x12.5-SA/400** 2x12.5 kW
- ▶ **PW3-25-SA/400** 25 kW



▶ POWER CUBE 25-SA/400 GENERATOR



www.ceia.net

CEIA reserves the right to make changes, at any moment and without notice, to the models (including programming), their accessories and options, to the prices and conditions of sale



The **Power Cube SA/400 Generator Series** is a high power Induction unit in a very compact size with embedded advanced microprocessor based control software and state-of-the-art electronics.

This allows **very high efficiencies (>96%) under a wide variety of workload conditions** while maintaining precise, stable and repeatable output power.

SA/400 GENERATORS SERIES WITH 12.5 kW AND 25 kW POWER

For more than 30 years CEIA has been manufacturing Inductive Heating Systems, achieving great experience in the field, and carrying out continuous R&D activities.

The **SA/400 Generators** and **Network Matching (Heating Head) hardware design** combined with a state-of-the-art power and control electronics allow an **extremely high conversion efficiency and therefore a high reliability and low operating costs**.

The embedded microprocessor control system is based on a wide feedback signals network, that allows a fine coil voltage and current control, and guarantees the consistency and accuracy of output power generation, suitable for highly repeatable production processes.

All the CEIA Generators are equipped with an isolation transformer that separates the coil output from the power supply line guaranteeing a high level of operator safety.

AUTOMATIC OUTPUT MATCHING TO WIDE LOAD IMPEDANCE

The **SA/400 Generators** adaption system to the load is **fully automatic**. The operator does not have to carry out any type of mechanical operation on the Generator or on the Heating Head.

This function selects the best Generator parameters, maximizing conversion efficiency at each set point power. This reduces the set up time and associated costs. Furthermore, during operation, a continuous and real time automatic tracking of the output matching is carried out in order to always meet the set point power even in case of workload condition changing. [i.e. heating temperature over curie point]. This provides for the greatest possible efficiency during the entire heating cycle.

The **SA Series Generators** are therefore ideal for **industrial production processes**, where the maximum reliability, repeatability and output power accuracy are required together with wide load matching flexibility, fast set-up and low operation costs.

FRIENDLY HUMAN MACHINE INTERFACE

A wide 7" high-resolution touch screen panel allows the operator to access programming function parameters quickly. All the process parameters are continuously displayed on the Main screen:

- Coil Voltage
- Coil Current
- Output Power Setting and Real time Reading
- Temperature Setting and Real time Reading
- Cooling Water Temperature and Flow
- Working Cell (Recipe)
- Generator Status (Alarm)



► MAIN SCREEN

MODULAR AND CONFIGURABLE SYSTEM

The Power Cube SA/400 Generator Series, due to its unique modular design, is available **in several configurations to satisfy different user requirements.**



Energy Saver

MODELS

PW3-12.5-SA/400

PW3-12.5-SA/400-2H

PW3-2X12.5-SA/400

PW3-25-SA/400

PW3-25-SA/400-2H

CONFIGURATIONS

12.5 kW generator
with single heating head output



12.5 kW generator
with dual alternative heating heads output



Double 12.5 kW generators
with dual simultaneous heating heads output



25 kW generator
with single heating head output



25 kW generator
with dual alternative heating heads output



ADVANCED CONTROL AND INTERFACE FUNCTIONS

The Power Cube SA/400 Generator Series, **equipped with advanced built-in controller**, includes the following CEIA accessories/options for an **accurate control of the process**.



WIRE FEEDER DISPENSERS [2]
for completely automated
brazing process



ANTI-OXIDIZING GAS DIFFUSER [2]

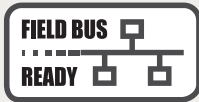

FIELD BUS INTERFACE
for an easy and fast implementation
into automation lines

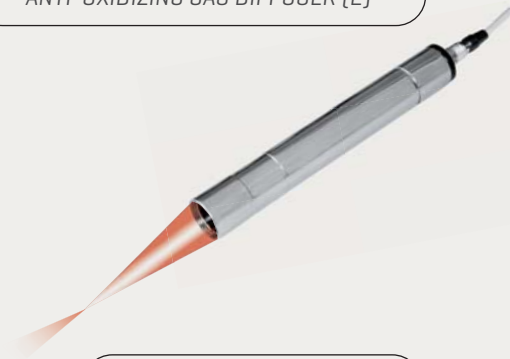

COMPACT PYROMETERS [2]



POWER CUBE
SA/400 SERIES

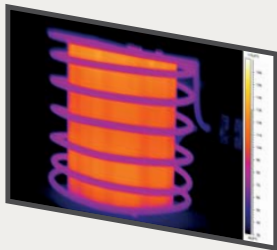

THERMO CAMERA CONTROL



THERMAL PROFILE CONTROL

WEB SERVER & DATA LOGGER
for remote service and quality control



Thanks to the **Thermal Profile Monitoring software**, coupled with the **SH/SLE Optical Pyrometers**, the user is now able to set specific temperature profiles, monitor and certify the heating process of each production item.

THERMAL PROFILE MANAGEMENT AND MONITORING

- Up to 20 Programmable Temperature and Time Segments per Process
- Up to 100 different storable processes
- Maximum Power Output Programmable for Each Individual Segment
- Temperature Tolerance Window Programmable for Each Individual Segment
- Out-of Tolerance and End-of-Cycle Outputs for Each Process

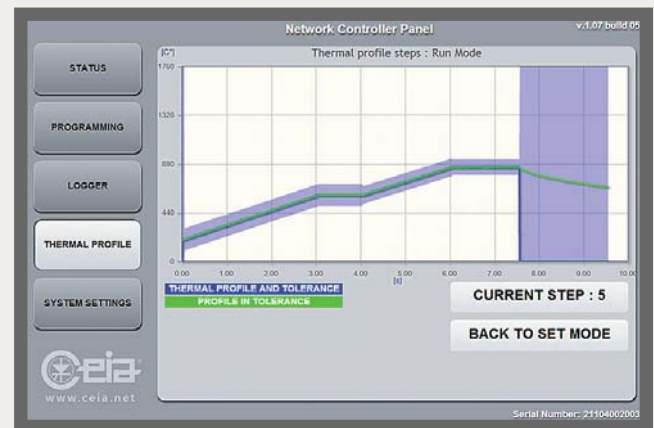

- ▶ Real-time Thermal Profile screen, combined with Web server and Data Log option

WIRE FEEDER CONTROL

- Control up to two independent Wire Feeders, one for each heating station
- Control parameters:
 - ▶ Quantity and speed of wire feeding
 - ▶ Quantity and speed of wire rewind
 - ▶ Activation time of alloy feeding
 - ▶ Wire feeding motor torque
 - ▶ Wire presence sensor

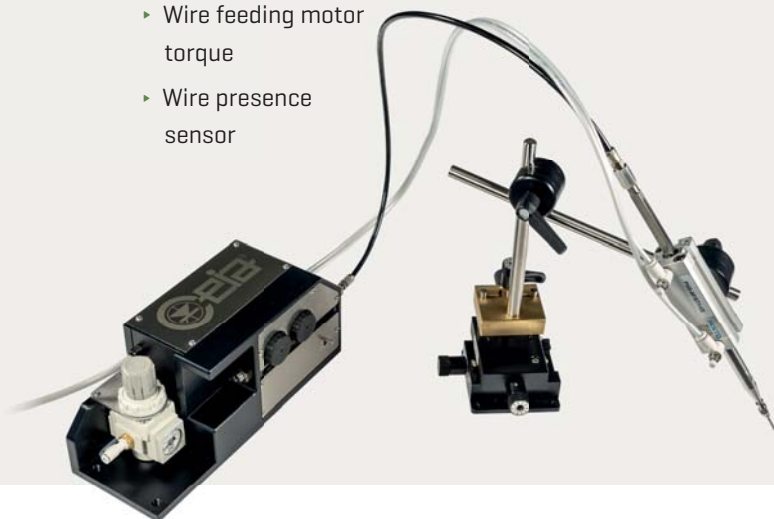

TIN SOLDERING CONTROL

- Optimized version for tin soldering
- Same features as the wire feeder control with the added special features

SPECIAL FEATURES

- Management of the automatic use of two wire feeders on the same piece to braze.
- Management of emissivity change [emissivity A and B] during the heating process
- Management of the brazing process without temperature control [heating time and two levels of programmable power]
- Management of the automatic use of two Wire Feeders on the same piece to braze, during the working mode "Thermal Profile" [only if the TP option is active].

The Power Cube SA/400 Series is equipped with **integrated Data Log and Web Server system**. It is possible to perform automatic data storage, for a proper process quality control, monitoring heating temperatures, output power, frequency, voltage and inductor current.

An Ethernet TCP/IP port allows access to the internal web server of the generator for remote programming settings and interface with SCADA / DCS systems.

INTEGRATED WEB SERVER AND DATA LOG SYSTEM

- Integrated Webserver with 2-port 100base-T Ethernet switch
- No client software required, only a web browser
- Zero configuration network for simple setup
- Built-in Rich Internet Application (RIA) for Status Monitoring, Remote Programming, Logging and Thermal Profile Management
- Internal storage capacity for more than 100,000,000 data samples

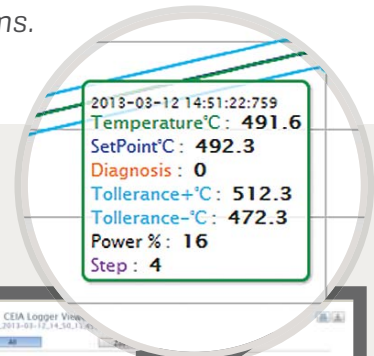

► Data Logger screen

FIELD BUS MANAGEMENT

- Management and control of the heating process via Field Bus protocol:
 - Profinet
 - EtherCAT
 - EtherNet / IP
 - Others upon request (DeviceNet, Profibus, CANopen, CC-Link, CompoNet, ControlNet, Modbus-RTU or TCP, SERCOS III)
- Field Bus and Network compliance certification available upon request

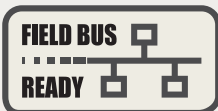

THERMOCAMERA CONTROL

- Interface with Thermocamera via a direct Ethernet connection on the Master Controller v3+
- Management of up to two independent zones of interest (ROI # 1 and ROI # 2).
- Ideal for temperature control on large surfaces or in applications where the location of the hot spot moves during the heating process (Max Temperature Spot Automatic Tracking)
- Simultaneous measurement and control of two different areas used to prevent over heating

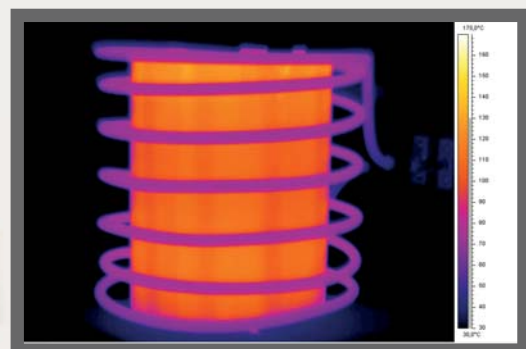

The Power Cube SA/400 Series is equipped with two standard connectors which allow **easy and reliable connections of all the INPUT and OUTPUT signals** of the generator.

INPUT / OUTPUT CONNECTIONS

The Power Cube SA/400 Series is equipped with two standard connectors which allow easy and reliable connections of all the INPUT and OUTPUT signals of the generator:

- Pyrometers
- Digital I/O
- Analog I/O
- Ethernet
- Field Bus
- Wire feeders



EXAMPLES OF APPLICATION

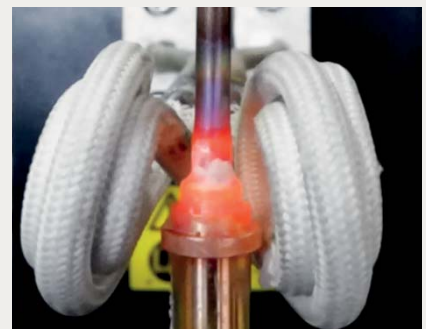
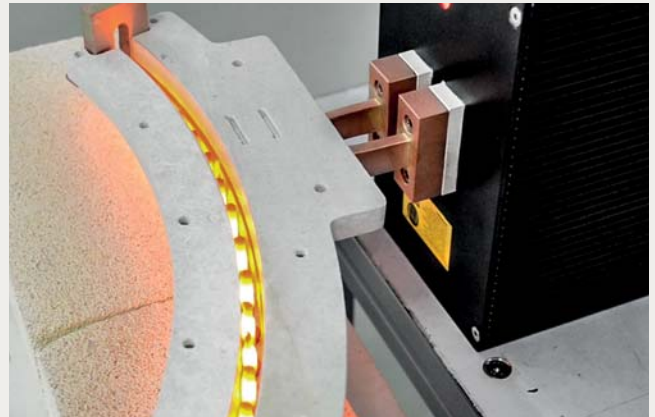

GENERATOR & HEATING HEAD DIMENSIONS



12.5-SA/400 & 25-SA/400

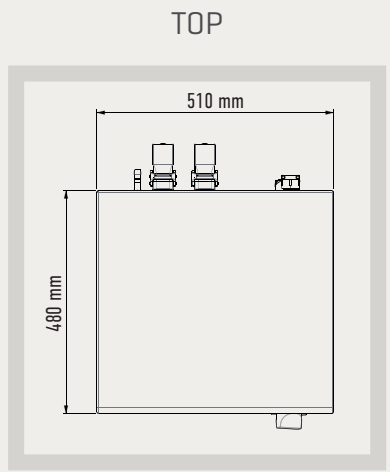
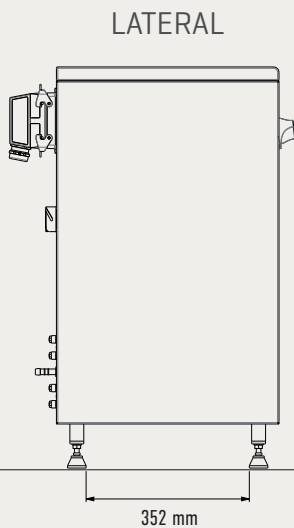
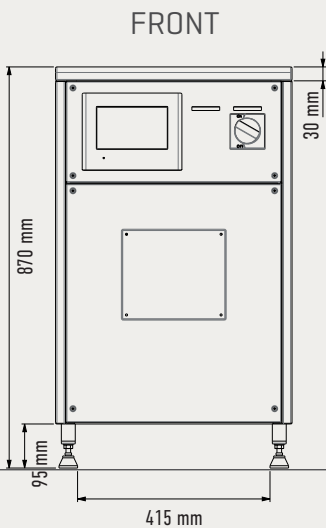

PWH-800

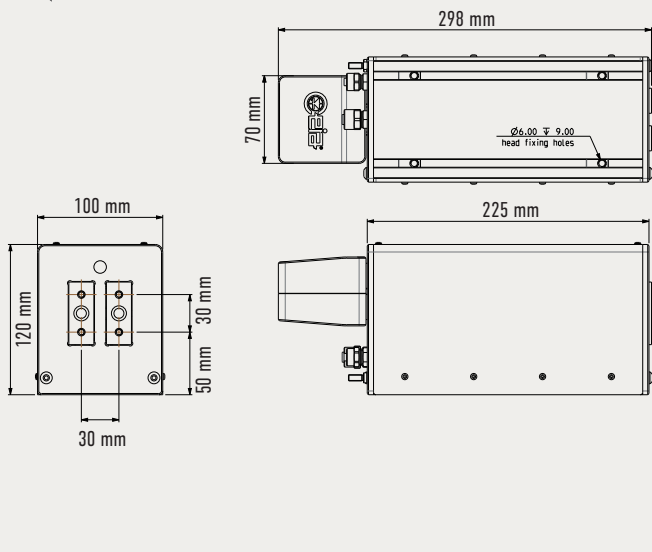

PWH-1600

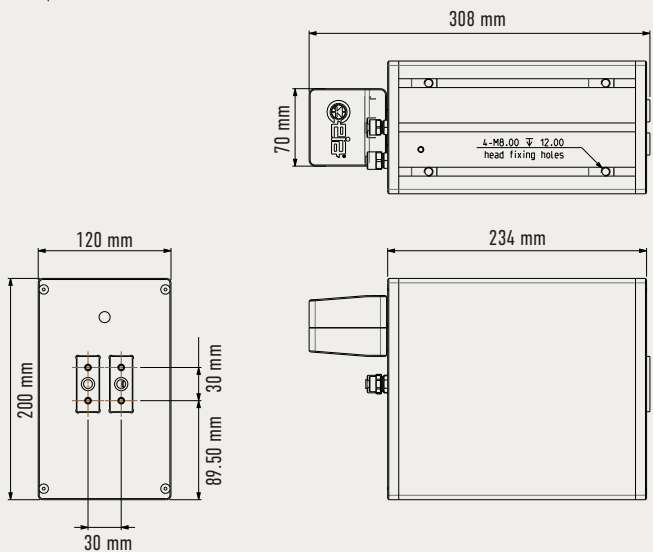

GENERATOR & HEATING HEAD SPECIFICATIONS

GENERATOR		PW3-12.5-SA/400	PW3-12.5-SA/400-2H	PW3-2X12.5-SA/400	PW3-25-SA/400	PW3-25-SA/400-2H
POWER SUPPLY AND POWER	Max. input power	12.5 kW	12.5 kW	2x12.5 kW	25 kW	25 kW
	Max. power at inductor	1000 kVAR	1000 kVAR	2x 1000 kVAR	2000 kVAR	2000 kVAR
	Power supply	400 Vac \pm 10%, three-phase - 50 Hz / 60 Hz, no neutral				
	Input current	23A max; external conductors 10 mm ² (min)	23A max; external conductors 10 mm ² (min)	46A max; external conductors 10 mm ² (min)	46A max; external conductors 10 mm ² (min)	46A max; external conductors 10 mm ² (min)
FREQUENCY RANGE		100 kHz... 400 kHz				
COOLING	Water cooling system	Direct off-take from mains at recommended pressure of approx. 4 bar (min. 2 bar, max. 8 bar)				
		Minimum flow rate: • Generator: 2,5 litres per minute • Heating coil: 2 to 10 litres per minute, depending on the coil used				
		Water temperature at inlet: from ambient temperature to 45°C (non condensing)				
OPERATING MODE		Continuous operation				
CONTROL MODE		Automatic (controlled by a CEIA control and monitoring unit)				
CONTROL AND MONITORING		Automatically stabilized heating power (not influenced by power supply voltage variations)				
SELF-DIAGNOSTICS	Visual and acoustic fault signal	Monitoring of cooling water temperature and flow				
		Monitoring for short-circuits in the heating conductor				
		Internal fault				
		Monitoring of inductor dimensioning				
		Monitoring of the heating head connection				
		Monitoring of the power supply voltage value				
OPERATING CONDITIONS		Operating temperature: + 5 °C to + 55 °C • Storage temperature: - 20 °C to + 70 °C • Relative humidity: 0 - 95% (non condensing)				
IP PROTECTION DEGREE		IP54				
WEIGHT		74 kg	79 kg	98 kg	97 kg	106 kg
SAFETY FEATURES		Galvanic isolation from the mains supply voltage				
		Complies with applicable international standards for Electrical Safety (EN 60204-1) and Electromagnetic Compatibility (EN 61000-6-2, EN 61000-6-4)				

HEATING HEAD	PWH-800	PWH-1600
WEIGHT	6.6 kg	12.6 kg
IP PROTECTION DEGREE	IP54	IP54

SH/SLE Compact Optical Pyrometers

CEIA offers a wide range of infrared optical sensors, equipped with low-intensity LED aiming, which covers an operating temperature range from 80°C to 2200°C.

FEATURES

- Adjustable emissivity from 0.1 to 1 [SH15/SLE series]
- High Accuracy
- High-Speed
- Very Compact design
- Temperature measurement independent from metal emissivity [SH2C/SLE series]
- Available with different focus distance and aiming spot size
- LED aiming light
- Supplied with Calibration Report traceable to Certified International Standards
- AISI 304 Stainless Steel Construction



SH15/SLE-550-D1 SH15/SLE-550-D2 SH15/SLE-550-D3 SH15/SLE-550-D4 SH2C/SLE

	SH15/SLE		SH2C/SLE	
			Single-color mode	Dual-color mode
TEMPERATURE RANGE	80... 2000°C		300... 2200°C	600... 2200°C
TEMPERATURE RESOLUTION	0.1 °C (up to 999.9 °C) 1 °C (above 1000 °C)		0.1 °C (up to 999.9 °C) 1 °C (above 1000 °C)	0.1 °C (up to 999.9 °C) 1 °C (above 1000 °C)
EMISSIVITY RANGE	0.1-1.0		0.1-1.0	N/A
RESPONSE TIME	100 µs Time Constant			
UNCERTAINTY	± 0.3% of reading in °C. All Pyrometers are supplied with calibration report traceable to certified International Standards			
MEASUREMENT SPOT AIMING	High Definition, 620 nm wavelength led beam			
INTERNAL DIGITAL CONTROLS	Offset and Range Calibration Parameters Environmental Temperature Measurement and Correction Automatic Gain Range Selection			
POWER SUPPLY	+/-15 V - +10/-5 mA, directly supplied by CEIA Controllers			
CONNECTION CABLE	Diameter 4.8 mm x Length 1.5 ... 4 ... 6 ... 9 m			
HOUSING	AISI 304 Stainless Steel			
WEIGHT	100 g			
PROTECTION CLASS	IP54 (IP65 upon request)			
OPERATING TEMPERATURE	0 °C to + 65 °C			
STORAGE TEMPERATURE	- 25 °C to + 70 °C			
CONFORMITY	Complies with applicable international standards for Electrical Safety and Electromagnetic Compatibility (EMC)			

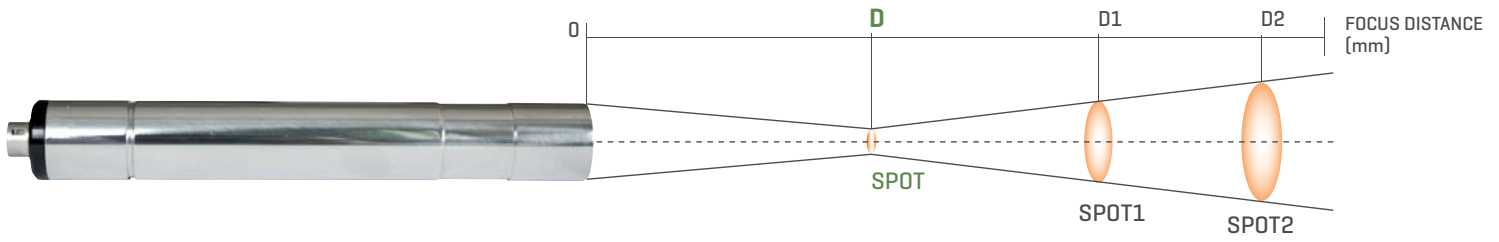

MODEL CONFIGURATION AND OPTICS DATA

MODEL	Close-up lens	D distance [mm]	Spot diameter [mm]	D1 distance 1 [mm]	Spot 1 diameter [mm]	D2 distance 2 [mm]	Spot 2 diameter [mm]
SH15/SLE-550-D1 80... 700°C	none	550	12.5	1000	36	2000	86
	CL240/SH15	240	4.5	500	24	1000	63
	CL120/SH15	120	2.5	250	19	500	52
	CL60/SH15	60	0.5	150	18.5	300	51
SH15/SLE-550-D2 120... 900°C	none	550	4.5	1000	21	2000	57
	CL240/SH15	240	1.5	500	18	1000	51
	CL120/SH15	120	1	250	17	500	46
	CL60/SH15	60	<0.4	150	19	300	50
SH15/SLE-550-D3 200... 1600°C	none	550	2	1000	16.5	2000	47
	CL240/SH15	240	0.6	500	16	1000	47
	CL120/SH15	120	<0.4	250	15	500	44
SH15/SLE-550-D4 500... 2000°C	none	550	2	1000	16.5	2000	47
	CL240/SH15	240	0.6	500	16	1000	47
	CL120/SH15	120	<0.4	250	15	500	44
SH2C/SLE 300... 2200°C	none	550	12.5	1000	36	2000	86
SH2C/SLE-240 300... 2200°C	none	240	4.5	500	24	1000	63

SH15/SLE: APPLICATIONS

- ANNEALING
- BONDING
- BRAZING
- CAP SEALING
- CURING
- FORGING
- HARDENING
- HOT FORMING
- LOCALIZED HEATING
- MELTING
- METAL GLASS SEALING
- NORMALIZING
- PREHEATING
- SINTERING
- SHRINK FITTING
- TEMPERING
- TIN SOLDERING

SH2C/SLE: APPLICATIONS

- HARDENING, FORGING, BRAZING, SOLDERING
- NOBLE METALS MELTING AND PURIFYING
- WIRE/ROD MILL
- SILICON PROCESSING
- GLASS INDUSTRY - GOB TEMPERATURE MEASUREMENT
- CEMENT INDUSTRY - CLINKER TEMPERATURE IN ROTARY KILNS

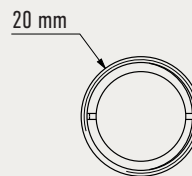
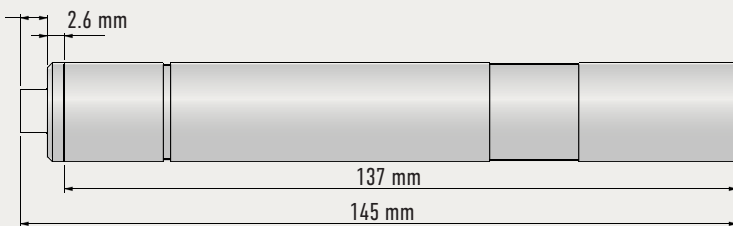

▶ ADDITIONAL LENS

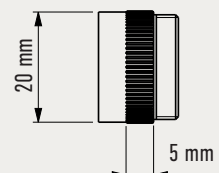



POWERCUBE SA/400 SE

CEIA HEADQUARTERS (ITALY)

The CEIA Difference

- ▶ Constant market share growth thanks to the recognized outstanding quality and reliability of the installed equipment

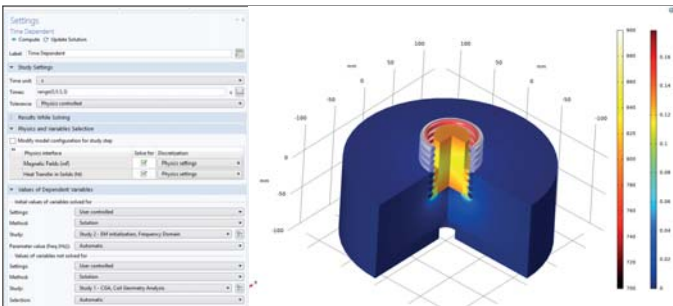

- ▶ Consolidated electromagnetic coil design and engineering capability



- ▶ ISO 17025 accreditation on Electromagnetic Testing



- ▶ Complete control and execution of the electronics manufacturing

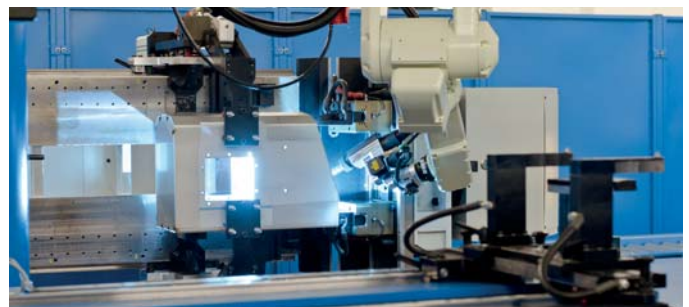

- ▶ Highly automated and repeatable mechanical manufacturing processes



- ▶ Digital Factory Testing, accurate automated calibration and final individual certification of the delivered equipment



CEIA - Zona Ind.le 54, 52041 Vicinaggio - Arezzo (ITALY)
 Tel. +39 0575-4181 • Fax +39 0575-418287 • E-mail: powercube@ceia-spa.com

www.ceia.net

CEIA reserves the right to make changes, at any moment and without notice, to the models (including programming), their accessories and options, to the prices and conditions of sale. DP040K0017v2000hUK- 2020

